

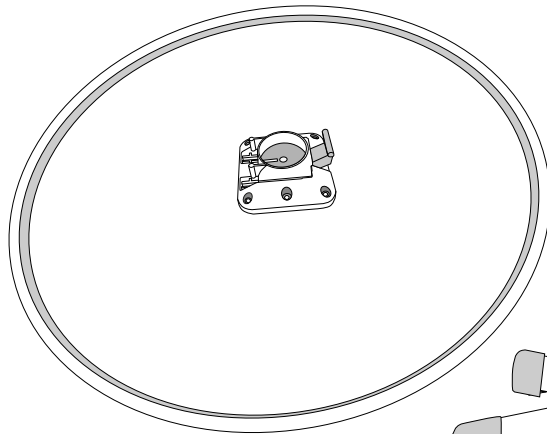





Montageanleitung Profitisch Amrum



- ① 1 Stück M10 Mutter 
- ② 1 Stück M10 Sicherungsmutter 
- ③ 1 Stück M10 * 680 
- ④ 2 Stück U-Scheibe  1 Stück Sechskantschlüssel 

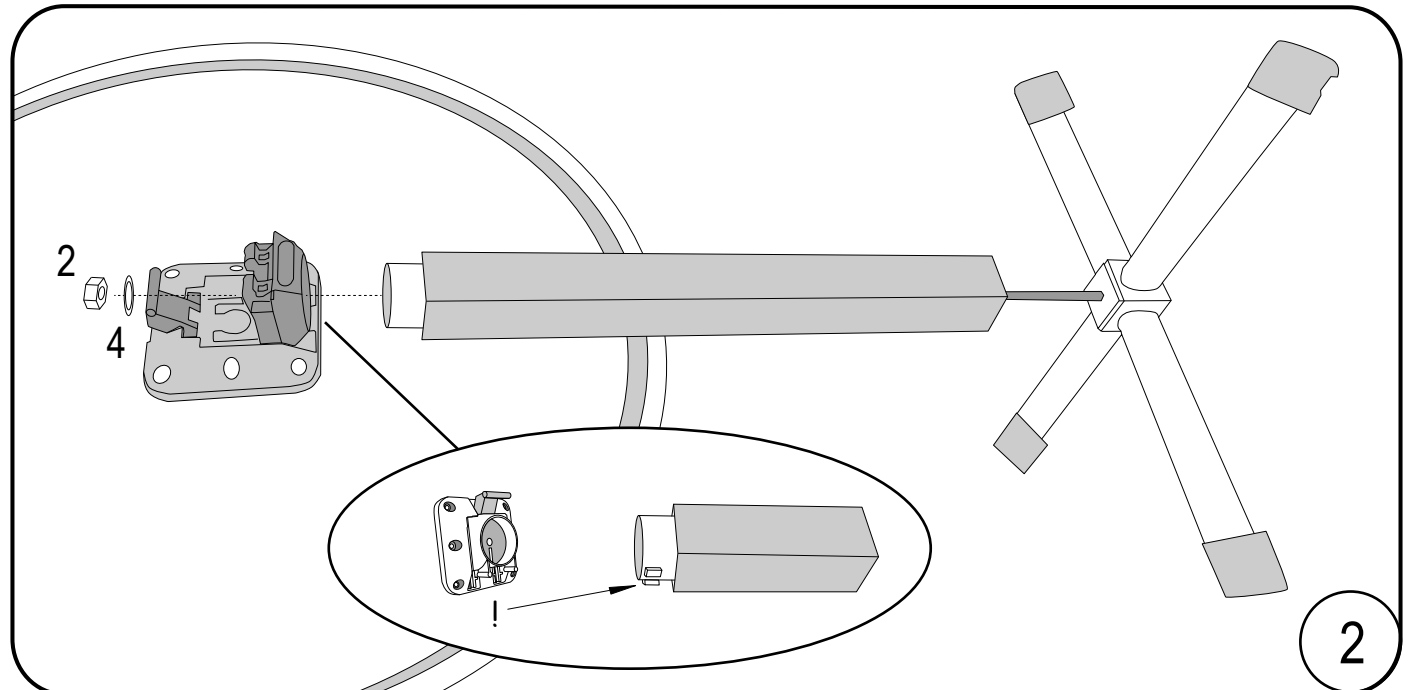
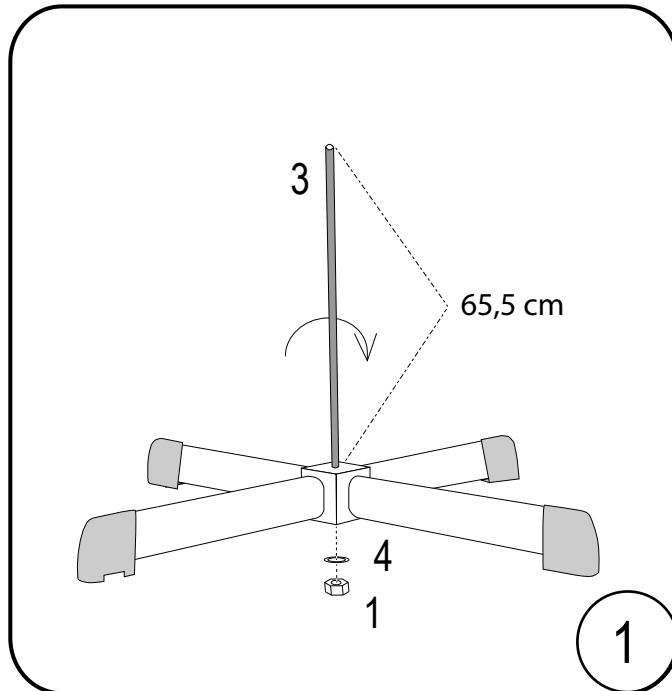
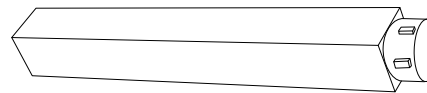
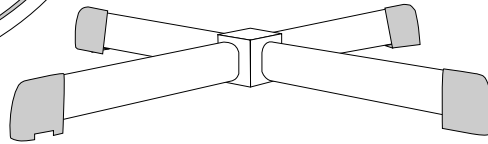

Einen schönen Sommer wünscht Ihnen Firma Müller